

# OELO



o  
e  
o

# How to use this manual ...

- 1 Familiarize yourself with the components PAGE 4-7
- 2 Hang/wire the Control Box PAGE 8-11
- 3 Hang the Cover components  
Acrylic Systems PAGE 12-13  
Metal Systems PAGE 14-15
- 4 Wire the system PAGE 16-21
- 5 Apply the finishing touches PAGE 21
- 6 Compare your structure to these samples PAGE 22-23



Below are key installation components you will want to familiarize yourself with before installing.

Control Unit



3-Core Wire    Power Cord



Mounting Screws



Boost Box

## Control Unit Components

**CONTROL UNIT:** The Control Unit provides 6 Signal Outputs (or Zones) and power for up to 300 lights per Power Supply (225' to 550' systems require additional Power Supply.)

**3-CORE STRAIN RELIEF:** Located on the bottom left of the Control Unit, this larger Strain Relief feeds the 3-Core Cable from the Control Unit to the rest of the system. (There is a second, optional Strain Relief port for additional 3-Core Cables, should you utilize more than 3 Signal Outputs.)

**POWER CORD STRAIN RELIEF:** Located on the bottom right of the Control Unit box, this Strain Relief feeds the pre-wired Power Cord from the Control Unit to the outlet.

**MOUNTING SCREWS + ANCHORS:** The (3) supplied screws attach the Control Unit Box to interior drywall (or exterior paneling).

**OPTIONAL BOOST BOX:** Provides additional power to systems with more than 300 lights, or Control Boxes without a second power supply.

## Wiring Components



3-Core Cable

**3-CORE CABLE:** Provides the system with three wires for positive (+VCC), ground (GND) and signal (S) wiring, used for connecting the Control Box to the light strand and or for adding Jumpers to a different Light Strand (see Page 17, Step 9 for Jumper instructions).



Pink Butt Connector

**BUTT CONNECTORS:** Provides a waterproof connection for multiple wires via crimping and heat shrinking.

**PINK BUTT CONNECTORS:** Used for "S" Signal wires; wires can be inserted into each of this narrow butt connector.



Blue Butt Connector

**BLUE BUTT CONNECTORS:** Used for +VCC and GND wires; each wire inserted into each end of this wide butt connector.



Light Strand

**LIGHT STRANDS:** Each light strand is made up of 40 LED lights and equates to roughly 30' linear feet in the system. Light strings can be spliced together for up to 300 lights. (Note: Light strings can be spliced together for up to 600 lights if additional power is introduced with second Power Supply or Boost Box. See Step 10 and 11.)



Light Clip

**LIGHT CLIPS:** Snap onto the LED light and then snap into the Cover to hold the light in place. The top of the light clip has a notch.



Cover Back

Screws

Cover Clip

Bottom of Cover

Inserting the Lens into the Back

Cover Lens

## ACRYLIC Cover Components

**ALUMINUM COVERS:** Together, the ACRYLIC system components on this page create the system’s weather-resistant housing for the lighting components. Covers come in 8' lengths; they can be cut down to size with a plastic saw or fine-tooth circular saw.

**COVER RUNS:** Any series of Covers that run together in one linear line.

**COVER BACKS:** Snap into the Endcap Backs and Extension Connectors (below) to provide housing for the Light String. The bottom of the Cover Back is thicker than the top.

**COVER CLIPS:** Position in between the Endcaps and Extension Connectors to support the system’s the Cover.

**COVER LENS:** Insert into the Cover Clip and over the Cover Back in the final stages to provide a weather-resistant structure for the lighting.

**COVER SCREWS:** Included with your kit to install Backs and Clips.

**ENDCAPS:** The Endcap is used at the start and end of a run.

**ENDCAP BACKS:** Screw to the fascia and provide a key locking fixture for the Cover.

**ENDCAP COVERS:** Snap over the ENDCAP BACK in the final stages to provide a weather-resistant structure for lighting components.

**EXTENSION CONNECTORS:** The Extension Connectors are used to connect Cover runs that are longer than 8'.

**EXTENSION CONNECTOR BACKS:** Screw to the fascia and provide a key locking fixture for the Cover.

**EXTENSION CONNECTOR COVERS:** Snap over the EXTENSION BACK in the final stages to provide a weather-resistant structure for lighting components.



Endcap Back



Endcap Cover



Extension Connector Back



Extension Connector Cover



## METAL Cover Components

**METAL COVERS:** Together, the METAL system components on this page create the system's structure for housing the lighting components. Covers come in 7.5' lengths (90"); they can be cut down to size with a metal-appropriate saw or hand shears. These covers are available in different bends to fit your structure.



**METAL COVER CAPS:** These "Caps" help complete the look of your metal install (for C, CS, CL and CLT Bends only). Not only do these caps act as End Connectors to seal the end of the channel for a finished, pest-free design, but they also double as Extension Connectors to help secure channel together for a seamless finish.



**METAL COVER SCREWS:** Included with your kit to install the Metal Cover and Caps. These screws are colored to match your Cover color.



**OPTIONAL METAL COVER BACKS:** If your Cover overhangs the fascia, these optional Cover Backs can be mounted on the backside of your Cover to seal your housing and to hide the wiring inside the Cover.

## Acrylic or metal system mounting inspiration

Oelo's cover systems can be mounted a variety of ways to achieve different lighting effects. Check out these website pages for inspiration:

FACE MOUNT      UNDER MOUNT

FACE MOUNT      UNDER MOUNT

[oelo.com/commercial-mounting-chart](https://oelo.com/commercial-mounting-chart)

[oelo.com/residential-mounting-chart](https://oelo.com/residential-mounting-chart)

## STEP 1

## Hanging the Control Unit

Control Unit



3-Core Wire Power Cord

Mounting Screws



**A. First, choose the Control Unit location.** The Control Unit can be hung indoors or outdoors but should be placed:

- i. Near a power source (a standard 120V outlet).
- ii. Near the start of the lighting channel.
- iii. **IMPORTANT:** Close to the property's WiFi router. (If WiFi is weak, the system can be connected to the Internet via an Ethernet connection.)

**B. Screw the box to the wall, using:**

- i. The (3) supplied screws and anchors (in the plastic bag) for interior drywall
- ii. Or 1 1/2" wood screws alone for exteriors

**⚡ WARNING:** Do NOT plug in the system until ALL wiring is complete. Wiring while the system is live will void warranty.

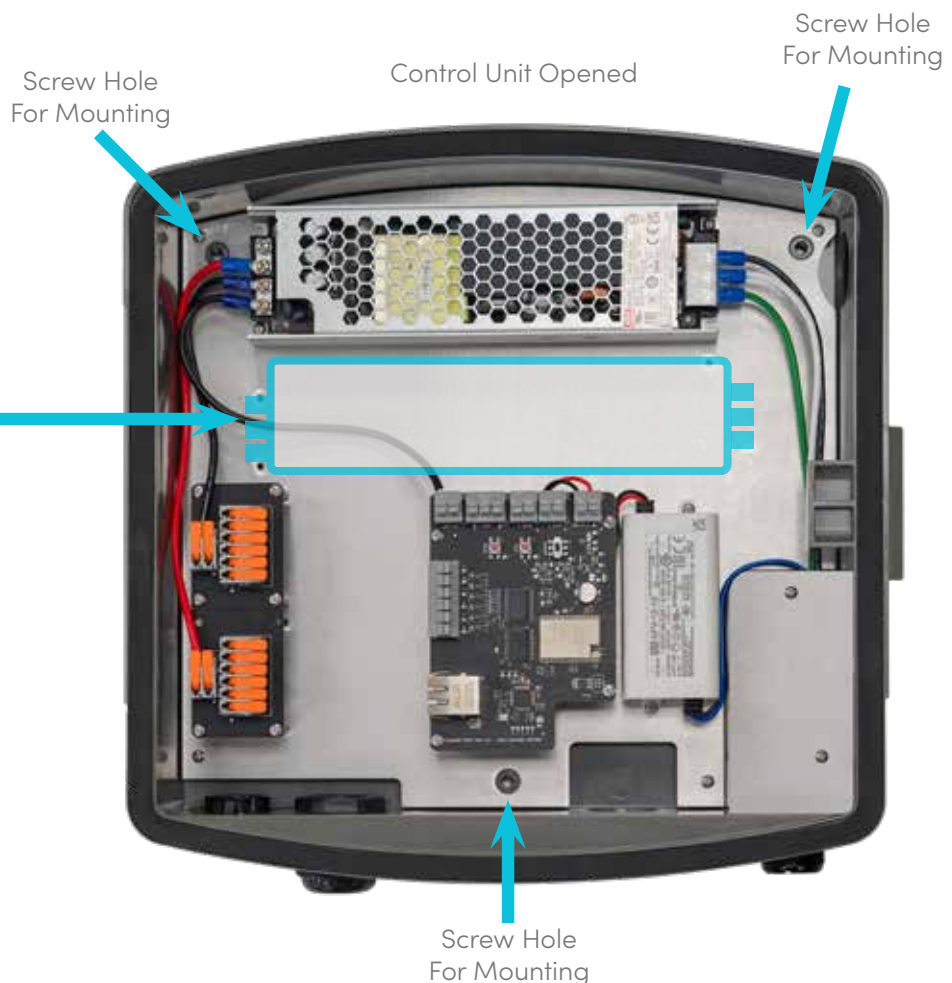

Second power supply to power to 300 additional lights. (This power supply is included on kits 225' and larger, or can be purchased separately for future system additions.)



## STEP 2



3-Core Cable  
(Available in black or white)

## Feeding/Wiring the 3-Core Cable/Control Unit

### A. Feed the 3-Core Cable in through the Large Strain Relief.

- i. The 3-Core Cable powers up to 300 lights or less.
- ii. Any System with more than 300 lights will require an additional power supply or Boost Box; see Step 10 and 11.

### B. Connect the 3-Core Cable wires, inserting the:

- i. Strip the **+VCC WIRE**, approximately 1/2", and insert into the **RED OUTPUT CONDUCTOR** (shown below) and close the conductor port.
- ii. Strip the **GND WIRE**, approximately 1/2", into the **BLACK OUTPUT CONDUCTOR** and close the conductor port.

IMPORTANT: Plug in the Controller and test for any 3-Core mis-wires before proceeding to the next step (connecting the S Wires). A mis-wire can cause damage to the Evolution Control Board. See the mis-wire checklist in the left rail of this page.

- iii. Strip the **S (Signal) WIRE**, approximately 1/2". Press and hold the button on the S Port #1 and insert into the wire. Do not have exposed wire showing. Release the button and gently tug on the wire to confirm secure connection. (For multiple zones, review the next page for further S Wire instructions.)
- iv. Give all the wires a gentle tug to insure tight connection.

### C. Run the wires up to the fascia where the Lighting Cover will start. Hold off for further wiring instructions (Steps 7-9).

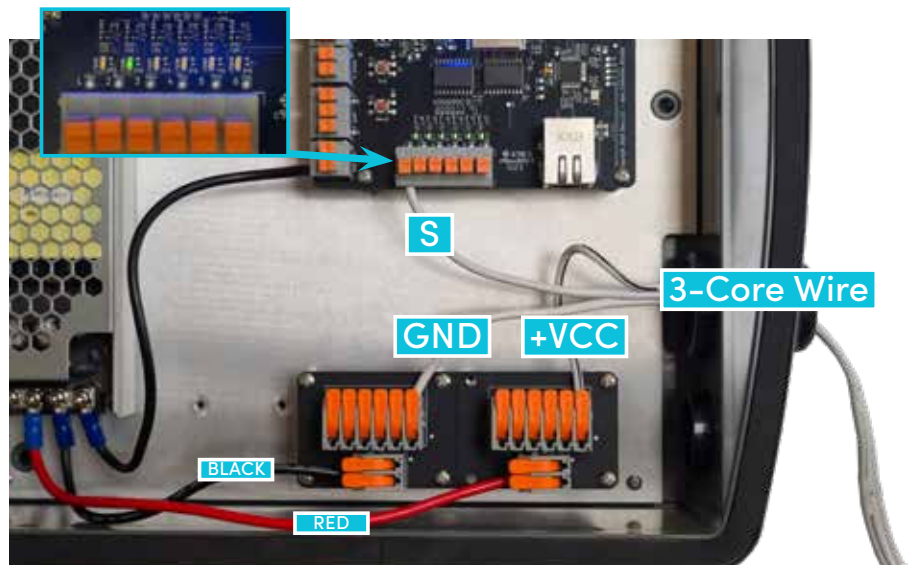

### MIS-WIRE CHECKLIST

- If the lights remain a constant blue**, unplug the control unit and proceed wiring the S (Signal) WIRE, following Step 2 iii. You're good to go!
- If the lights do not illuminate at all**, re-investigate for a mis-wire, starting at the Control Box and working down the LED strand, checking each wired connection. Repair and retest.
- If the lights are blue but stop working at a certain point in the LED strand**, please inspect before (and after) the unlit section for a mis-wire. Repair and retest.
- If the lights flash**, inspect wiring for a possible short, like a punctured wire (from a screw) or a severed wire. Repair and then retest.
- If the lights still are flashing**, inspect that you are not overdrawing the light transformer; each power supply can power roughly no more than 300 lights. Repair and retest.

## Creating multiple zones for different lighting effects

Oelo's state-of-the-art controller has **SIX INDIVIDUALLY ADDRESSABLE OUTPUTS**, which allows you to control six zones separately from one controller for creative, hybrid installs and out-and-down lighting effects!

### What are zones?

Zones are separate light strand outputs that you can control independently from one another, allowing you to run different colors, movements and patterns from each zone. Each Oelo Controller can support up to six Zones. Before installation, your installer would have determined how best to illuminate your structure(s) and if zones were needed.

Below is an example of how zones can be utilized:

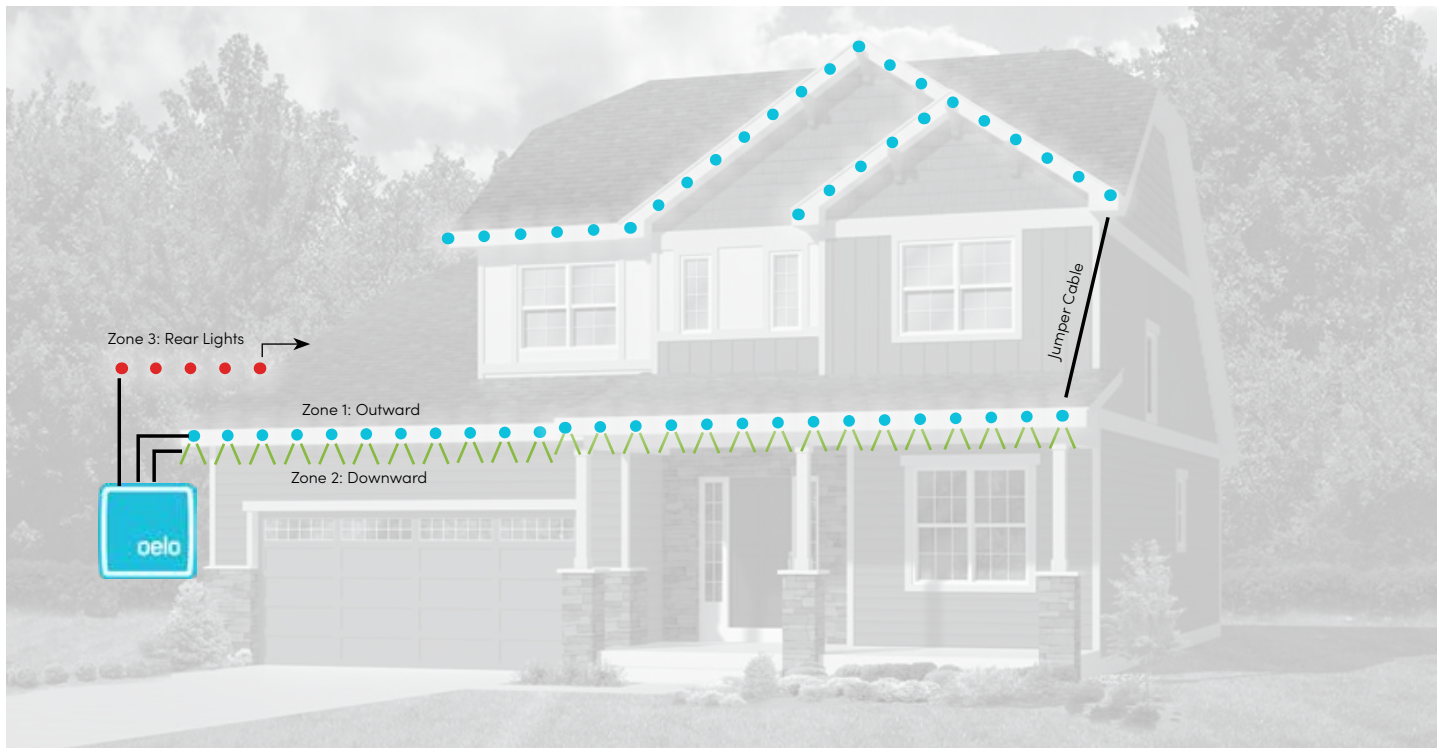

**ZONE 1:** The first Zone runs across the first- and second-floor facade, facing **OUTWARD**, to create traditional lighting.

**ZONE 2:** The second Zone is hung **DOWNWARD** to create a wall-wash effect, as well as security/spotlighting.

**ZONE 3:** A third Zone is installed on the **REAR** of the home for its own separate backyard/patio lighting.

## STEP 2 continued

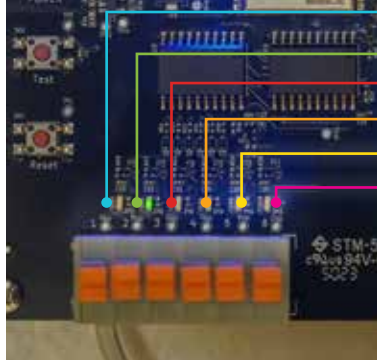

- Zone 1 Signal Output
- Zone 2 Signal Output
- Zone 3 Signal Output
- Zone 4 Signal Output
- Zone 5 Signal Output
- Zone 6 Signal Output

Be sure to note where your Zone go (ie. Front Out, Front Down, Building Rear, Building #2, etc.) for future app programming.



Zone Outputs

## Feeding/Wiring the 3-Core Cable/Control Unit

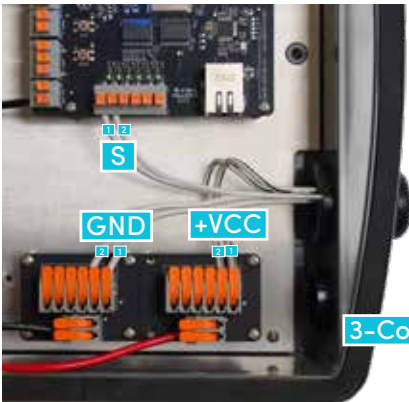

- A. Feed another 3-Core Cable into the Large Strain Relief.
  - i. The 3-Core Cable powers up to 300 lights. or less.
- B. Connect the 3-Core Cable wires, inserting the:
  - i. Connect the **+VCC WIRE** and **GND WIRE**, replicating the Page 9, Step 2B instructions. Note: Insert the next **S (Signal) WIRE(s)** into the next numbered port(in sequential order). If you have more than 3 Signal Wires/Zones, use the second Large Strange Relief to insert your 3-Core Wire into the Control Box. Any system with more than 300 lights will require an additional power supply or Boost Box; see Steps 10 and 11.

oelo Light Count		
Zone	Location	#LEDs
1	_____	_____
2	_____	_____
3	_____	_____
4	_____	_____
5	_____	_____
6	_____	_____

**TIP!:** Use the supplied label to document your zones and apply this sticker inside your control box.

## STEP 3 (ACRYLIC SYSTEMS)

## Hanging/cutting the Cover Components

Hang/cut Cover to align with the Endcap Back center line.

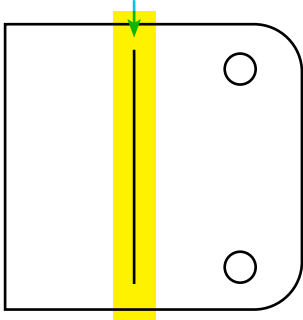

Hang/cut Cover to align with the Extension Connector Back center lines.

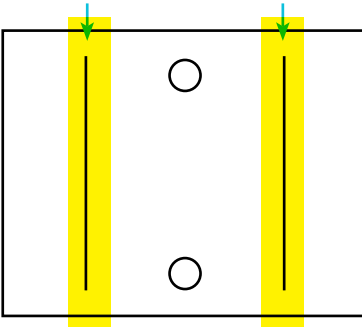

**IMPORTANT:** (Don't over-tighten the Endcap Backs, Extension Connectors or Cover Clips as parts could become damaged or components will not seal together properly.)

### A. Hang the Endcap Backs on the structure's fascia using the supplied screws.

Endcap Backs should be mounted as follows:

External corners	1/8" - 1/4" away
Internal corners	About 1" away
Below overhang (Gutters or trim pieces)	About 1/8" below
Spacing between Endcap Backs and Extension Connectors	The Cover comes in 95" increments and is designed to grow and shrink with outside temperatures; align the Cover to the center lines indicated on the left diagrams for this shrinkage and/or expansion.  The Cover can be cut for shorter distances utilizing these same guides; cut your Cover Back and Cover Lens clipped together to ensure they are cut to the same length.

### B. Extension Connectors can be added if the channel run is longer than 95".

Screw the Extension Connectors Backs into the fascia using the supplied screws.

Extension Connectors should be mounted as follows:

For runs 5' or shorter	Use one Cover clip in the middle of the run
For runs longer than 5'	Use two Cover clips, placed evenly along the run
Below overhang (Gutters or trim pieces)	About 1/8" below

### C. Using the supplied screws, hang the Cover Clips.

Hang clips approximately every 24".

External corners	About 1/4" away
Below overhang (Gutters or trim pieces)	About 1/8" below

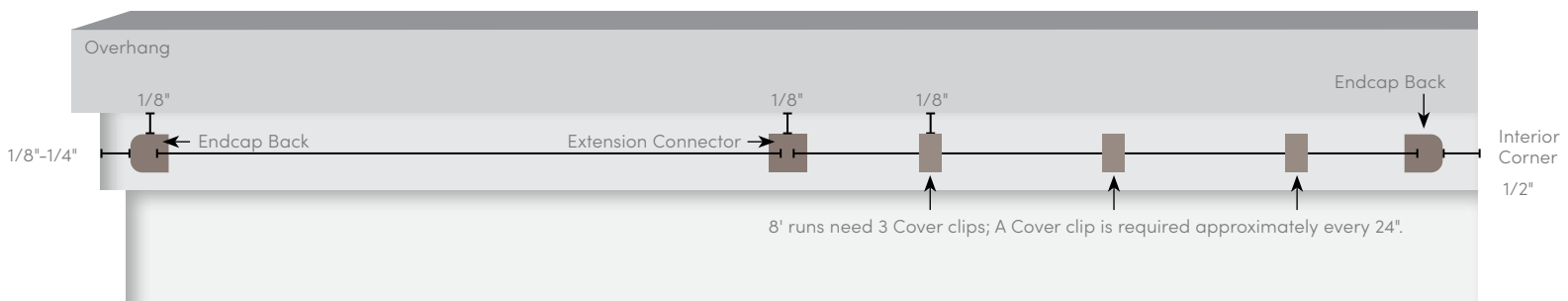

## STEP 4 (ACRYLIC SYSTEMS)

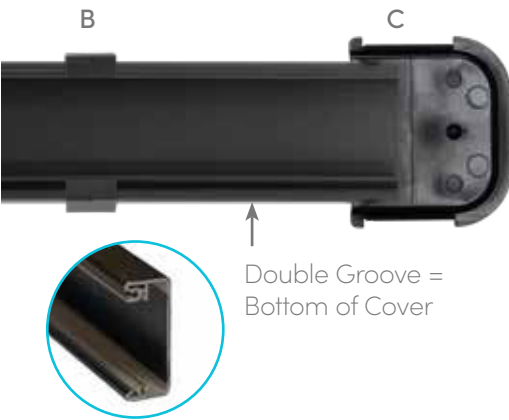

## Inserting the Cover into the Endcap Backs

- Remove the Cover Lens from the Cover.
- Insert the top of the Cover Back into the Cover Clip and push the bottom of the Cover into place. If the Cover Back is difficult to insert, use a flat-head screw driver to bend the bottom lip of the Cover Clip for easier installation.
- Slide the Cover to align with the center line guide(s) (noted in Step 3).
- Continue to mount the Cover pieces using the above steps.

## STEP 5 (ACRYLIC SYSTEMS)



## Placing the 3-Core Cable into the Cover

- Insert the 3-Core Cable into the Endcap Back:
  - This cable will supply power and signal up to 300 lights (~250 linear feet of lights). Systems with 300+ lights will require a Boost Box; see Step 10.)

## STEP 6 (ACRYLIC SYSTEMS)

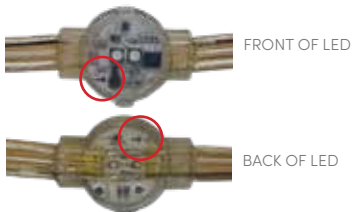

These arrows **MUST** point away from Control Unit (in the direction of signal travel).

Align, rotate, insert

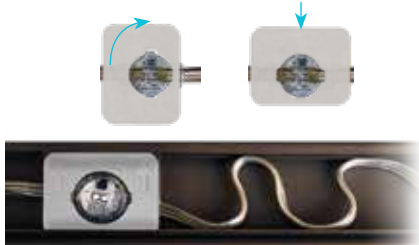

Create slack in the wire

## Inserting the Light String into the Cover

- IMPORTANT:** Locate the small arrow on the front and back of the Light Strand. The Oelo lighting system has directional input/output, and this arrow MUST be pointing AWAY from the start of the system/Control Unit.
- Align, insert and rotate a Light Clip onto the first light in the Light Strand string, noting that the notched side is the top of the Light Clip. (To insert the light, align the clip/light grooves, then rotate the clip so the notch is located on top.)
- Insert the top of the Light Clip into the top of the Cover and then push the bottom of the Light Clip into the bottom of the Cover.
- Continue adding Light Clip/Lights to the Cover, keeping spacing consistent to maintain a uniformed look. If a light ends up inside the Extension Connector Back, twist the wire to reduce the spacing slightly. Create slack in the wire so as not to overstretch the strand.
- Once the run reaches a corner or gap, the Light Strand can run outside of the Cover, or a Jumper Wire can be added to connect Light Strands together for longer distances from one Cover to the next. (See Step 9 for Jumper Wiring.)

## STEP 3 (METAL SYSTEMS)

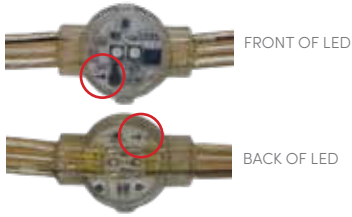

These arrows MUST point away from Control Unit (in the direction of signal travel).

## Inserting the Light Strand into the Cover

- A. **IMPORTANT:** Locate the small arrow on the back of the Light Strand. The Oelo lighting system has directional input/output, and this arrow MUST be pointing AWAY from the start of the system/Control Unit.
- B. Remove the protective film and place the Light Strand into the Cover.
- C. **Insert the First Light at the beginning of the Cover.** 1. At an angle, slip the light into the opening. 2. Then rotate the light for a secure lock.
- D. **Continue inserting Lights into the Cover until the Cover is full.** Once the Cover is full, hang that Cover (Step 5). Continue to insert lights and hang the Covers as you go.



## STEP 4 (METAL SYSTEMS)

### Locate the 3-Core Cable near your first Cover

- A. **Place the 3-Core Cable into the first Cover:** This cable will supply power and signal for up to 300 lights. Do not wire until Step 7. Note: Systems with more than 300 lights will require a Boost Box or Power Supply (Pages 18-20).

## STEP 5 (METAL SYSTEMS)

### Hanging the Cover Components

**RECOMMENDED!:** Insert the Light Strand and hang the Covers one at a time.

- A. **The Cover can hang facing Outward (Traditional) or Downward (Wall Wash).**
  - i. Hang Covers flush for a seamless appearance.
  - ii. The Cover should be mounted as follows:



OUTWARD



DOWNWARD

## STEP 5 CONTINUED

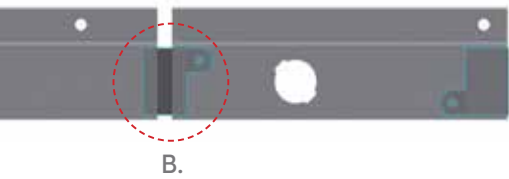

- B. Using the supplied screws, hang the Cover, using the mounting holes. Additional holes may be added using an appropriate drill bit and screws.

- i. Hang the Cover, then insert an End/Connector Cap into the cover, then screw the cap into the structure using the supplied screws. (A notch allows for lights and wires to run through it.)
- ii. Insert the Light Strand into the next Cover and install using the Cap to anchor it for a flush, seamless appearance.

## Cutting the Cover Components

- C. Once the run reaches a corner or transition, the Covers can be cut. Use a metal-appropriate saw blade or hand shears, as well as eye protection, when cutting the Covers. Here's how best to miter cut corners and peaks:

### If the Cover is facing Outward (Traditional):

And is a Corner: Cut Cover at a 45° top-facing angle

And is a Peak: Cut Cover at a 45° front-facing angle

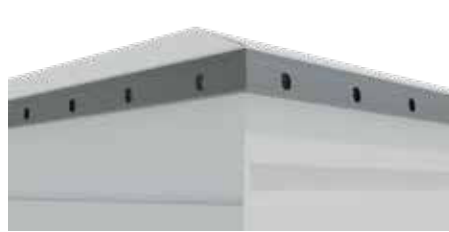

Outward Corner



Outward Peak

### If the Cover is facing Downward (Wall Wash):

And is a Corner: Cut Cover at a 45° front-facing angle

And is a Peak: Cut Cover at a -45° top-facing angle



Downward Corner



Downward Peak



- D. Once your run is complete, screw an End/Connector Cap to the structure (with the screw/hole tab facing inside the Cover). The Cap will complete your look and reduce pests getting into the Cover. Mount the Cover over the End Cap. If the Cover overhangs the fascia, a Cover Back can be mounted to the back of the Cover to enclose the Cover and hide wires.

## Pro Tip:

As you hang your Cover, you can wire along the way to reduce the number of times you go up and down a ladder.

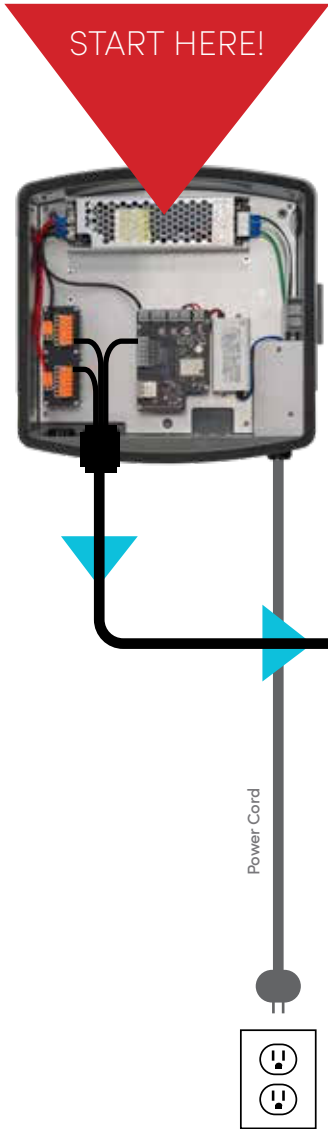

START HERE!

Power Cord

3-Core Cable

UPPER LEVEL

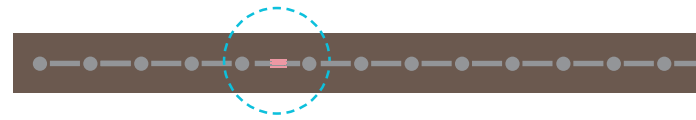

STEP 8 END OF 40-LIGHT STRAND

## Pro Tip:

Heat the wires with a Butane Torch to easily strip them of their insulation.



40 LIGHTS (~30 LINEAR FEET)

STEP 7 MAIN LEVEL

**REMINDER:** Make sure the LED's arrow is pointed away from the box. →

STEP 7

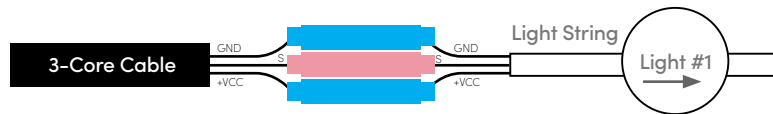

## Connecting the 3-Core Cable to Light Strand 1

- Take note that all wires are labeled with GND, S or +VCC.
- Strip, feed, crimp and shrink the following:
  - GND to GND using a **BLUE CONNECTOR**
  - S to S using a **PINK CONNECTOR**
  - +VCC to +VCC using a **BLUE CONNECTOR**

Crimp the Butt Connectors on each of the indented center section, making a strong physical connection between the 2 Light Strands.

Use a Butane Torch to shrink the Butt Connectors, distributing the heat evenly. Stop when you see glue coming out of the seams of the connector.

Use Electrical Tape to wrap around the new connection for an extra layer of protection.

## WARNING:

Do NOT plug in the system until ALL wiring is complete. Wiring while the system is live will void Oelo's warranty.





STEP 9

### STEP 9



## Adding "Jumpers" to connect distant or upper lights

- A. Strip, feed, crimp and shrink the Light Strand's **GND**, **S** and **+VCC** wires to a Jumper 3-Core Cable's respective **GND**, **S** and **+VCC** wires.
- B. Strip, feed, crimp and shrink the Jumper 3-Core Cable's **GND**, **S** and **+VCC** wires to the next strand of light's respective **GND**, **S** and **+VCC** wires.

STEP 9

STEP 8

### STEP 8



## Connecting Light Strands together (every 40 lights)

- A. Each light strand is made up of **40 LED lights** and equates to roughly 30 linear feet in the system. Light strands can be spliced together for up to 300 lights. Once you reach the end of a light strand, strip, feed, crimp and shrink the end of the strand to a new strand with a **BLUE** or **PINK** Butt Connector (shown in diagram above), matching the respective wires:
  - i. The end of the light strand's **GND** wire to the new strand's **GND** wire.
  - ii. The end of the light strand's **S** wire to the new strand's **S** wire.
  - iii. The end of the light strand's **+VCC** wire to the new strand's **+VCC** wire.

JUMPER WIRE

## STEP 10

Note: We recommend consulting Oelo on Boost Box strategies for any light systems with more than 300 lights.



### WARNINGS:

Do NOT leave copper wiring exposed.

Do NOT plug in the system until ALL wiring is complete. Wiring while the system is live will void Oelo's warranty.

## Adding a Boost Box (if needed)

The Control Unit can only power 300 lights from one Power Supply; however, a Boost Box (Step 10) or additional Power Supply (Step 11) can be added to power another 300 lights. If the system is linear (ran in a straight line), you can add a Boost Box after Light #300. This Boost Box can also be added anywhere in the run to help offset non-linear systems, or it can be added at the end of the run to backfeed power. To add a Boost Box:

- A. Hang the box near a nearby power source (a standard 120V outlet).
- B. Insert the 3-Core Cable into the Large Strain Relief.
- C. Connect the 3-Core Cable wires, inserting the:
  - i. **+VCC WIRE** into the **RED CONDUCTOR**; close conductor port.
  - ii. **GND WIRE** into the **BLACK CONDUCTOR**; close conductor port.
  - iii. The **S (Signal)** WIRE will not be used inside the box.
- D. Run the 3-Core Cable up to Light #301, or sooner, and strip, feed, crimp and shrink:
  - i. The Boost Box Cable's **GND** wire **AND** Light Strand 300's **GND** wire **TOGETHER** into one side of the **BLUE** Butt Connector; crimp with the next Light Strand's **GND** into the other side of the Butt Connector.
  - ii. Insert the Boost Box Cable's **+VCC** wire in a **BLUE** Butt Connector with the new Light Strand's **+VCC** into the other side of the Butt Connector.
  - iii. Insert Light Strand 300's **S** wire into a **PINK** Butt Connector with the new Light Strand's **S** wire.
  - iv. Use a Butt Connector to cap off and waterproof the Booster Box's **S** wire by heating and pinching it closed, and the Light Strand 300's **+VCC** wire; these wires will not be used.
- E. Continue wiring your system, connecting and jumping light strings as needed.

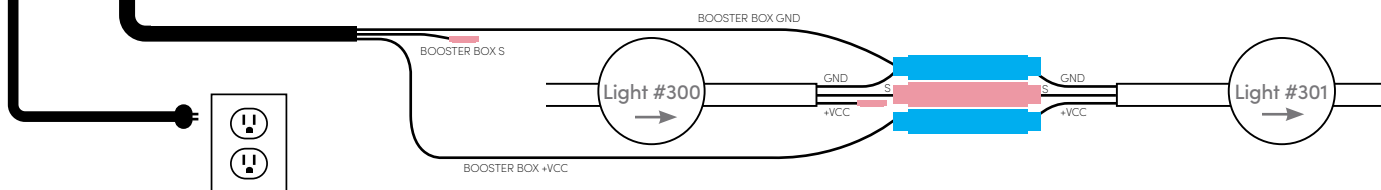
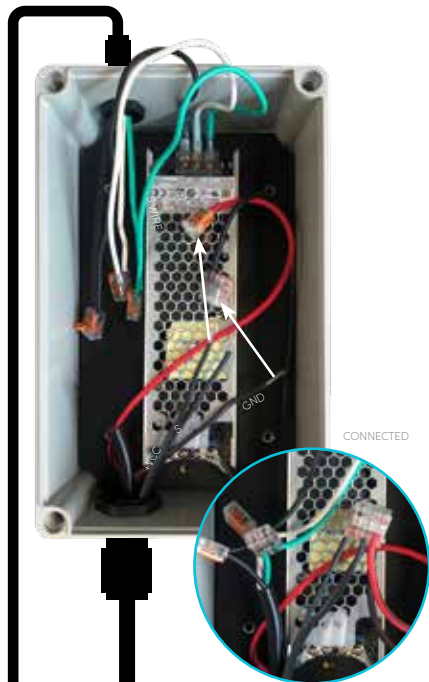

# Below are some Boost Box wiring samples:

----- S = Signal  
----- +VCC = Positive  
----- -GND = Negative

## EXAMPLE 1

### 475 LIGHTS TOTAL

From multiple outlets, you can run the Signal and Voltage all the way around the exterior by introducing power midway in the light run with a Boost Box (and second 120V outlet). Note: The Control box with 1 Power Supply can power up to 300 lights by itself.

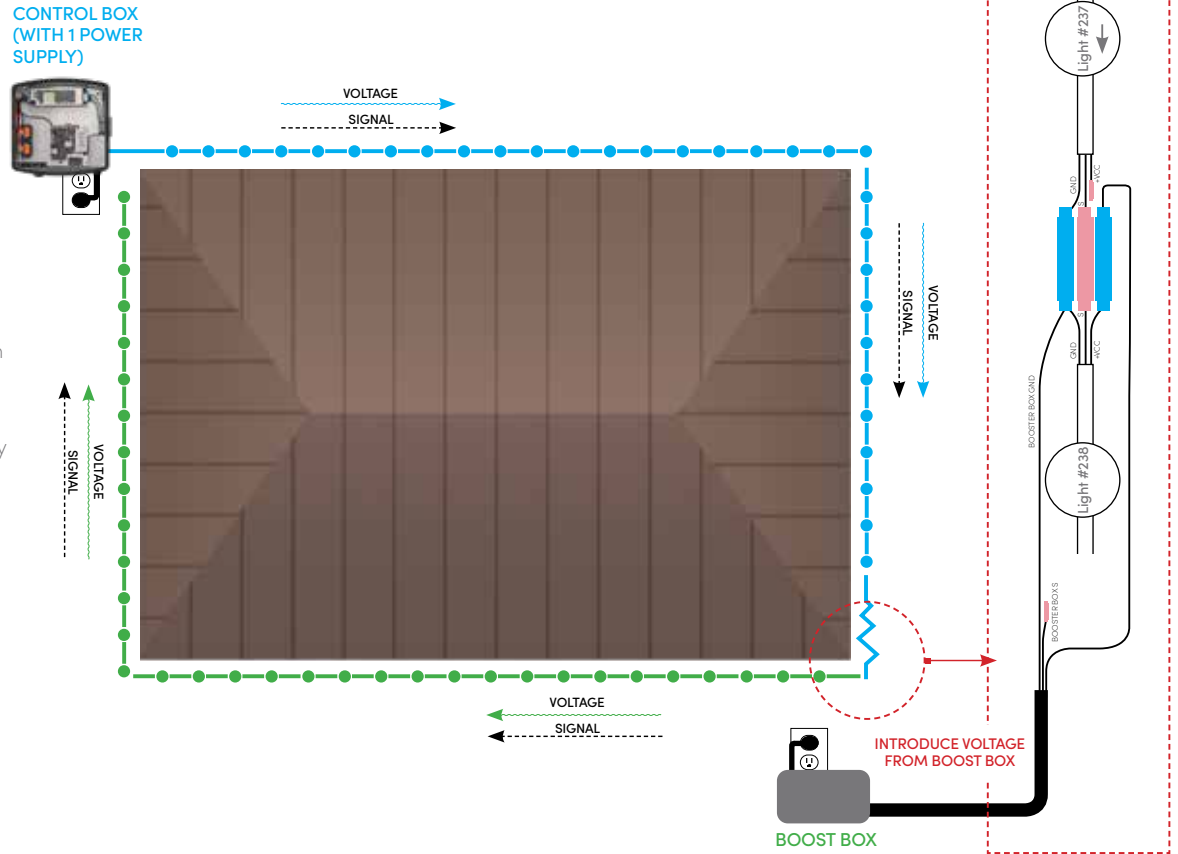

## EXAMPLE 2

### 440 LIGHTS TOTAL

From the Main Controller (with single Power Supply), you can power up to 300 lights. At the end of the 301+ run of lights, you can backpower the Voltage from a Boost Box (and second 120V outlet).

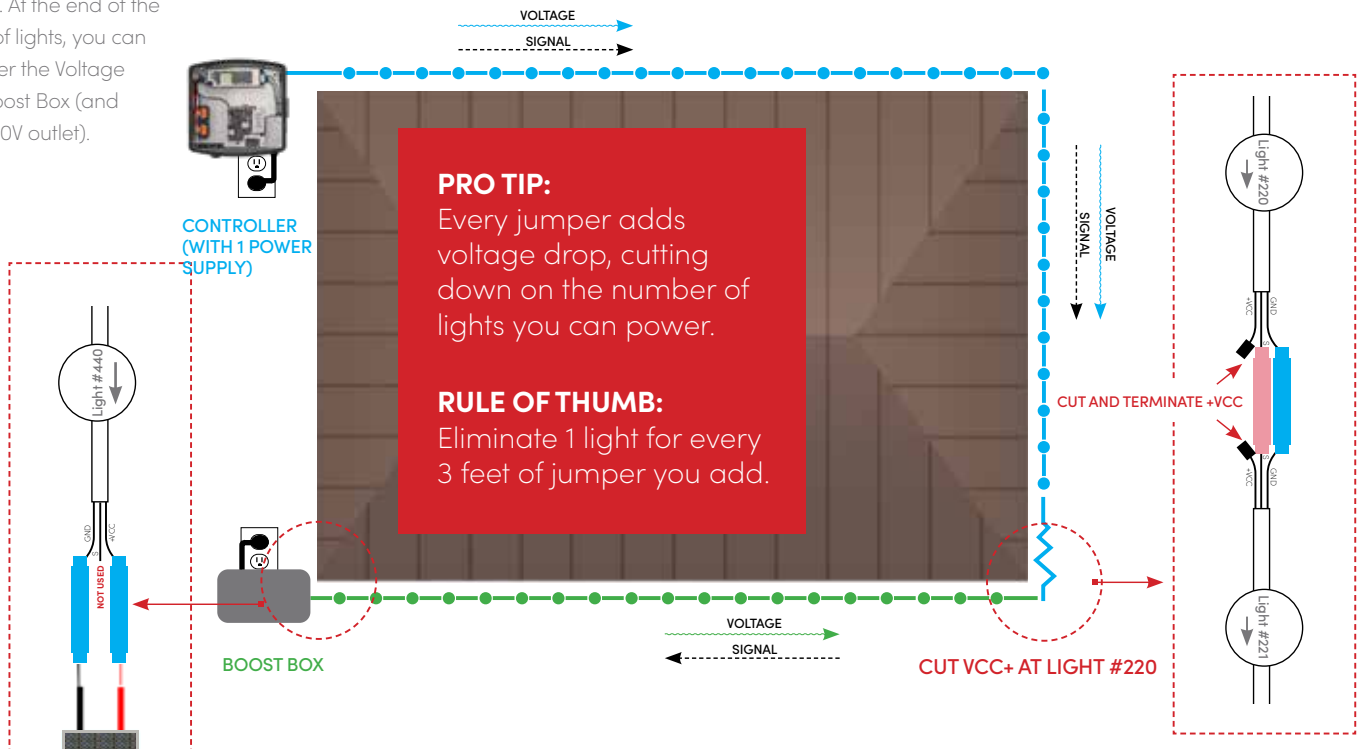

# STEP 11

## Using a second Power Supply (if needed)

The Control Unit can only power 300 lights from one Power Supply; however, an additional Power Supply can be added to power an additional 300 lights. The below diagrams show example wiring scenarios:

### EXAMPLE 1

#### 600 LIGHTS TOTAL

From the Main Control Box (with 2 Power Supplies), you can power up to 600 lights, powering the second set of 300 lights by backfeeding from the second Power Supply.

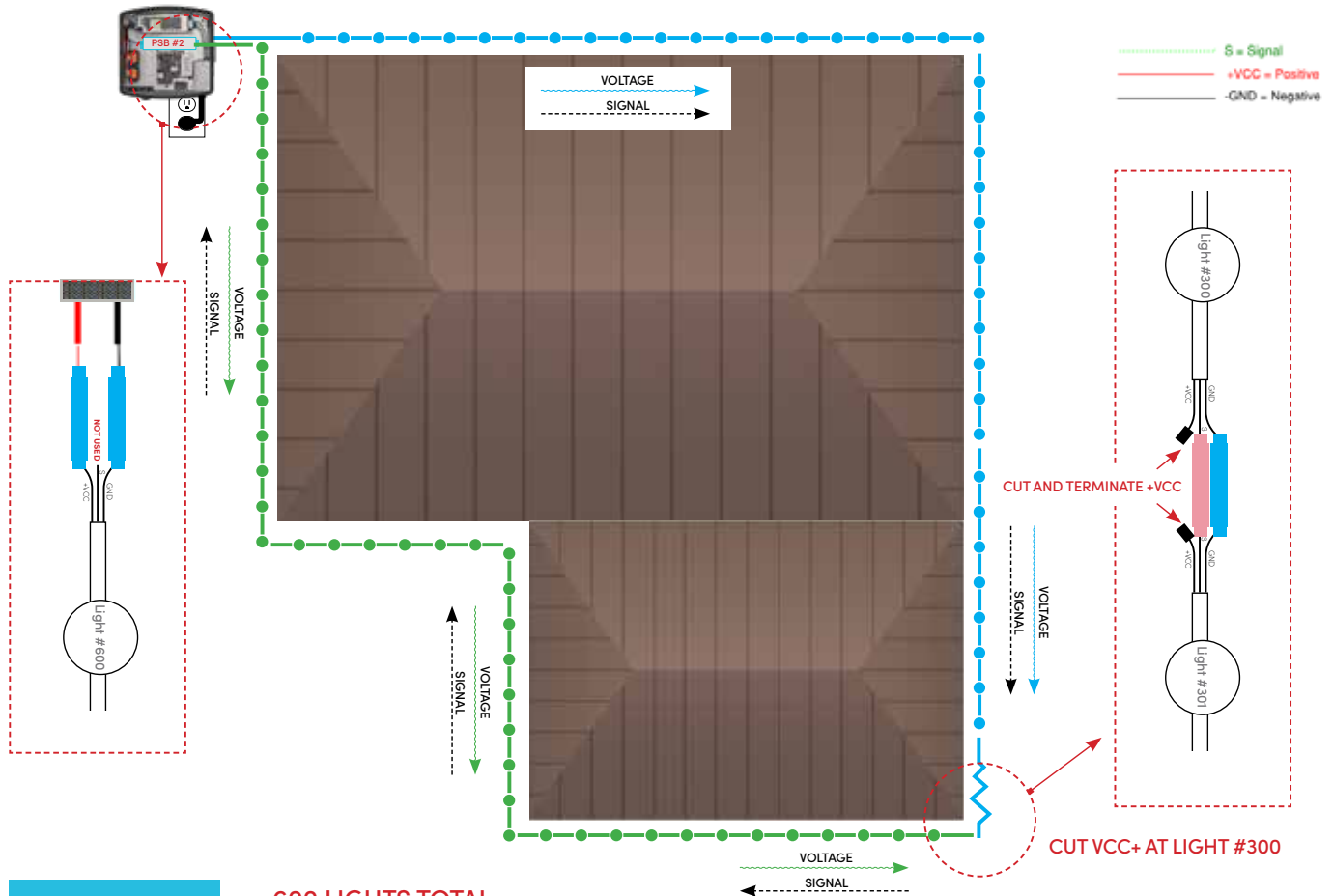

### EXAMPLE 2

#### 600 LIGHTS TOTAL

With Oelo's new Controller, you can power multiple zones, up to 300 lights per Power Supply.

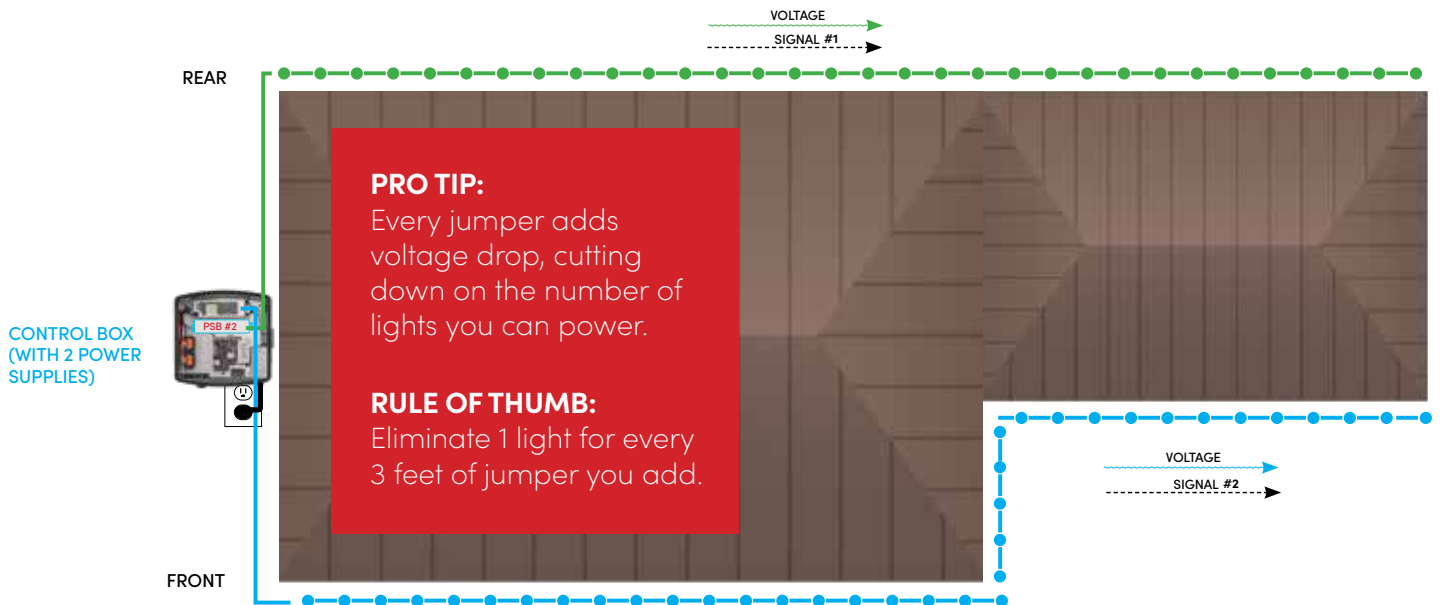

## STEP 11 CONTINUED

# Second Power Supply wiring ...

### A. Please make note of the second Power Supply's wiring.

- i. Power Supply #2's **+VCC WIRE (RED WIRE)** is stripped and fed into the loose Wago. The Power Supply's **GND WIRE (BLACK WIRE)** is stripped and fed into the other loose Wago. (Kits purchased with 2 Power Supplies are pre-wired.)
- ii. Each Power Supply can power up to 300 lights. Once you have used the circuit-board mounted Wagos from Power Supply #1 for 300 lights, you will need to run the next 3-Core **+VCC WIRE** to the loose Wago (with **RED** wire) and that 3-Core's GND Wire to the loose Wago (with **BLACK** wire). All 3-Core **S (Signal) WIRES** will be inserted into the Signal Port.

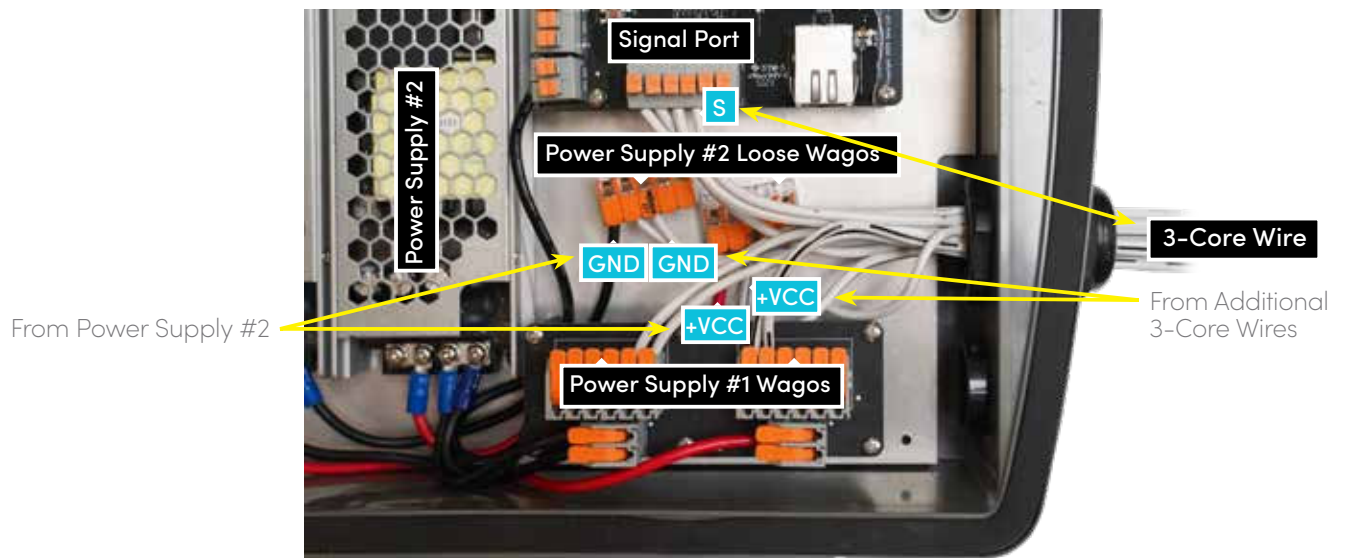

## STEP 12

# The finishing touches

### A. Waterproof the end of the system.

Use Butt Connectors to waterproof the end of the Light Strand wires. Heat up and pinch closed with pliers, making sure it seals around the wire.

### B. Plug in the Control Unit and additional Booster Boxes and test the system.

Follow the instructions on Control Panel Door to test or troubleshoot the lights. For instructions on how to operate the Oelo Evolution App, please see the Oelo Evolution App manual guide.

### C. For Acrylic systems, snap on the Cover Lens, sliding it into the top of the Cover Clip. If the Cover Lens is difficult to insert, use a flat-head screw driver to bend the bottom lip of the Cover Clip for easier installation. Snap on the Extension Covers, lining up the tabs. Snap on the Endcap Covers, making sure the wires are tucked into the ports.

### D. Admire your stunning work!

# SAMPLE LIGHTING SCENARIOS

Light Strand #1 = ● ● ●

Light Strand #2 = ● ● ●

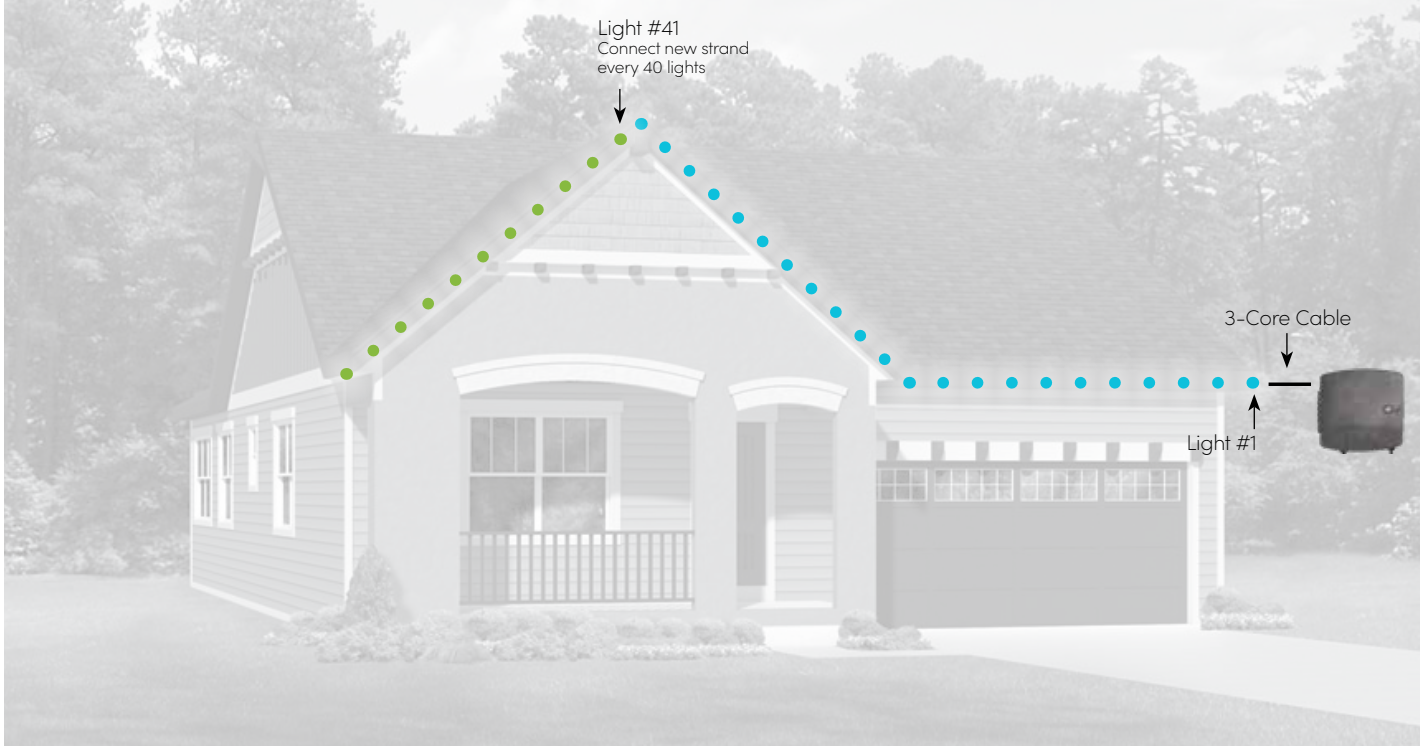

50-Foot System ~60 Lights (2 Light Strands)

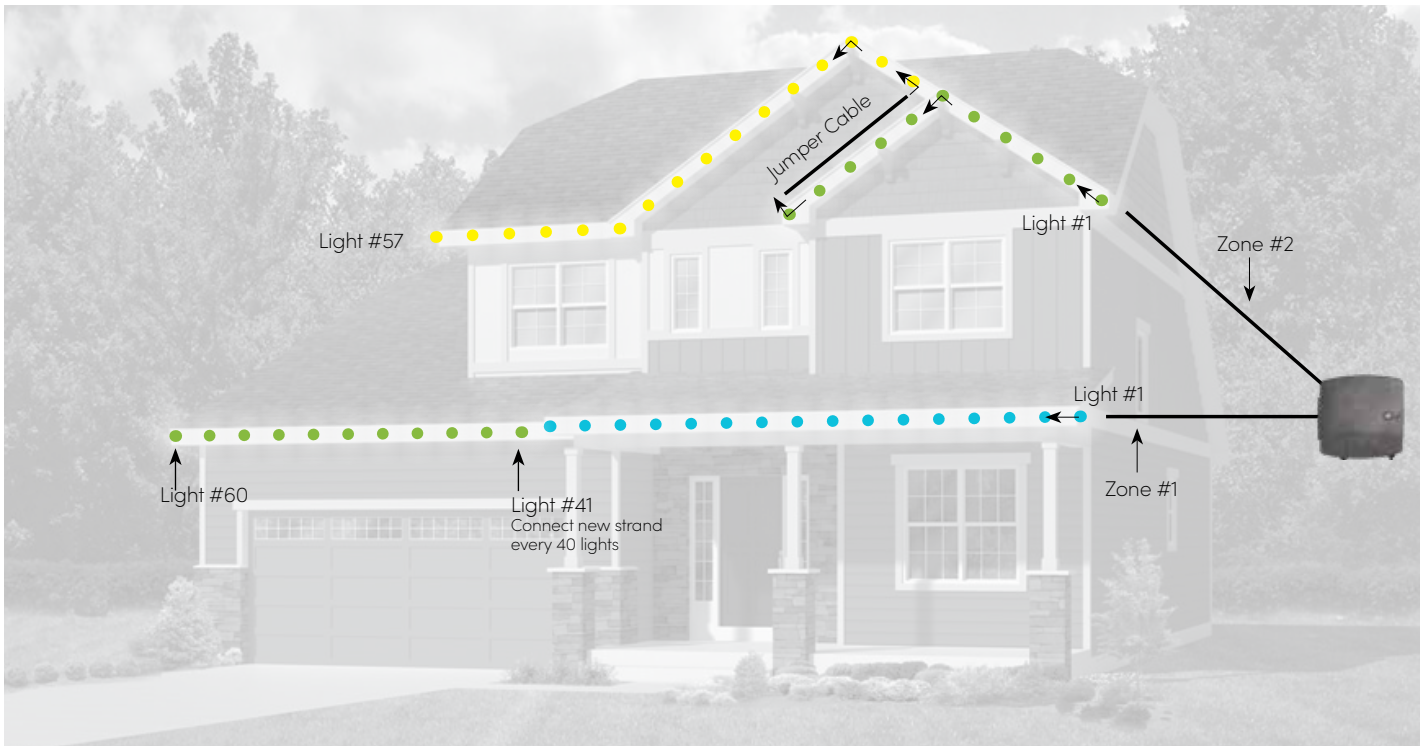

100-Foot System ~120 Lights (3 Light Strands)

Light Strand #3 = ● ● ●

Light Strand #4 = ● ● ●

Light Strand #5 = ● ● ●

Light Strand #6 = ● ● ●

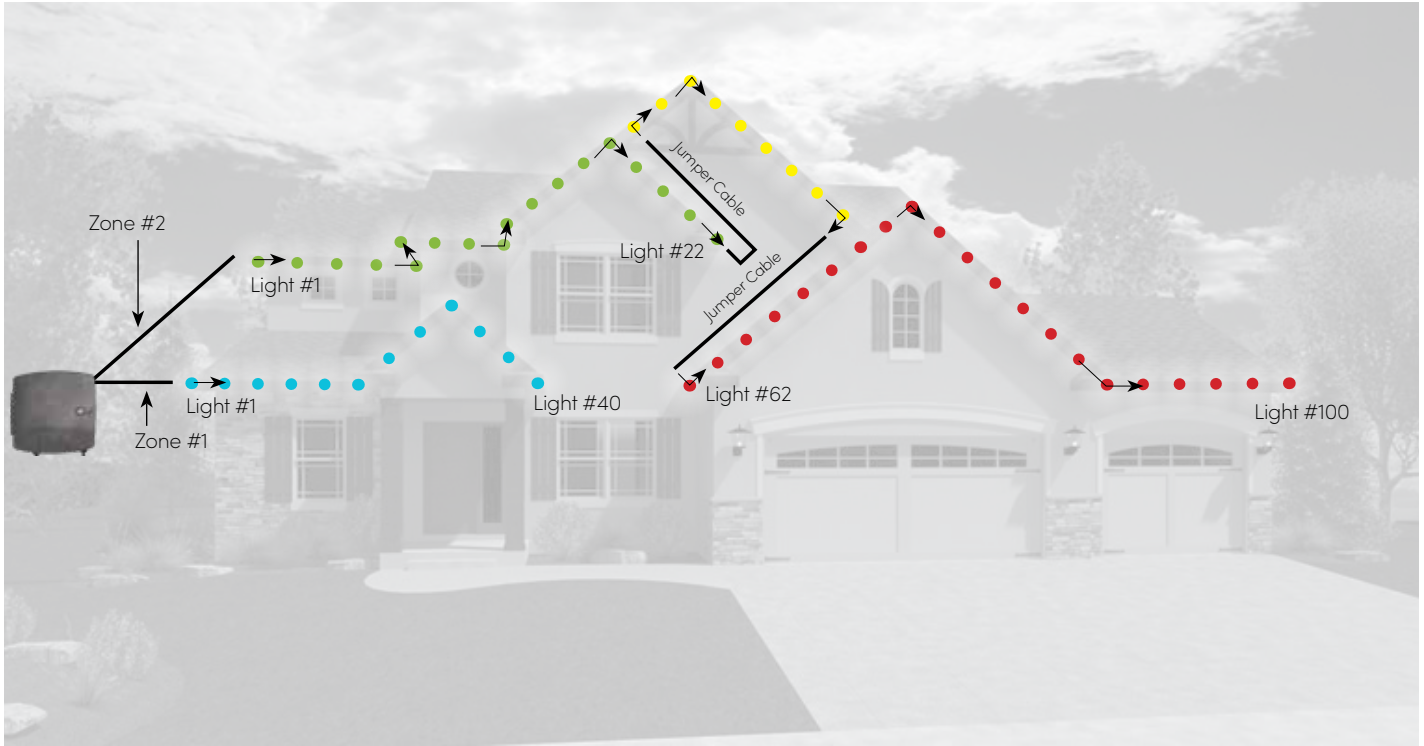

### 150-Foot System ~180 Lights (4 Light Strands)

**HOW TO CREATE A JUMPER CABLE** For complete "Jumper Cable" instructions, see Page 11.

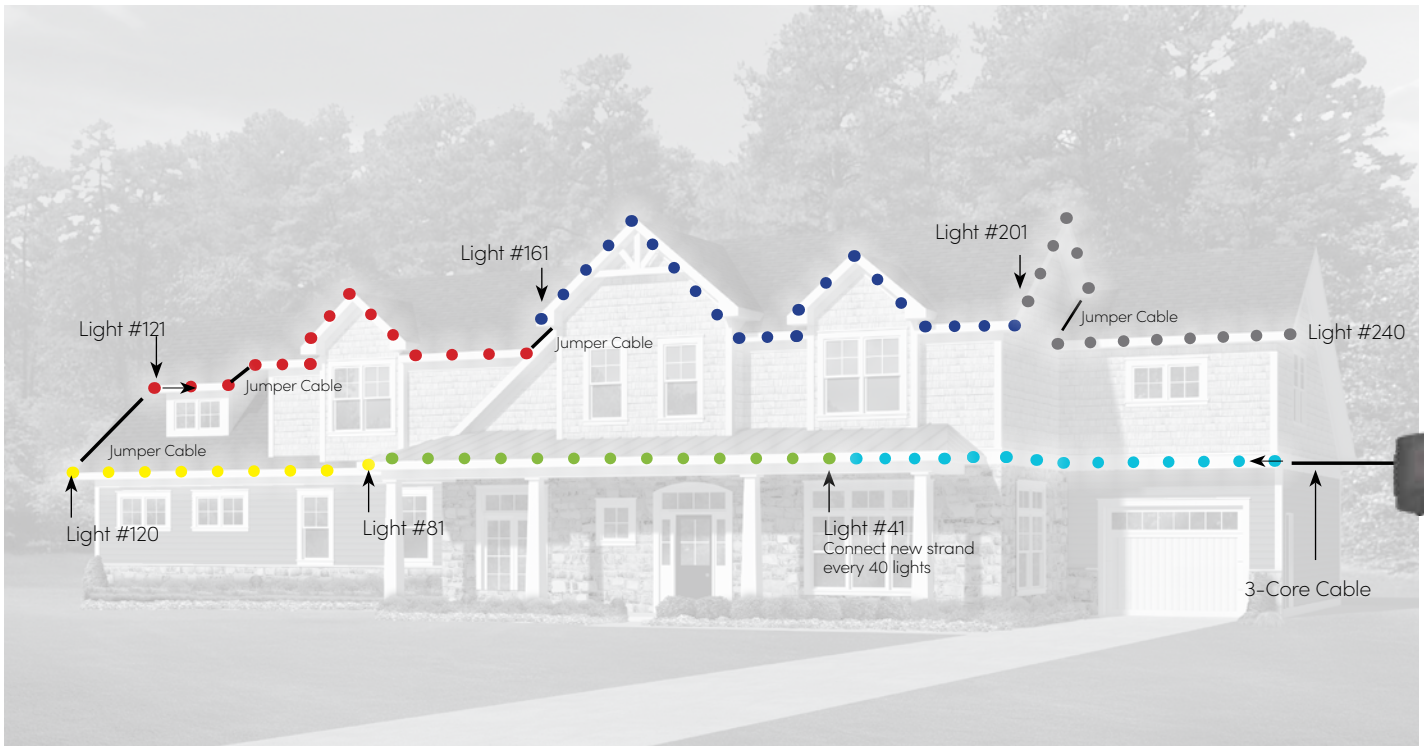

### 200-Foot System ~240 Lights (6 Light Strands)

**HOW TO INSTALL A BOOSTER BOX** For 300+ light homes or non-linear structures, we recommend consulting Oelo; also see Page 12 for Booster Box details.

# oelo

LIGHTING SOLUTIONS

[oelo.com](http://oelo.com) | 3842 Redman Dr., Fort Collins, CO | 970.212.3670